

4. External Appearance



C panel



S panel

5. Feature

- ◆ Multi-connection outlet pipe method: left/right/rear, more flexible for installation.

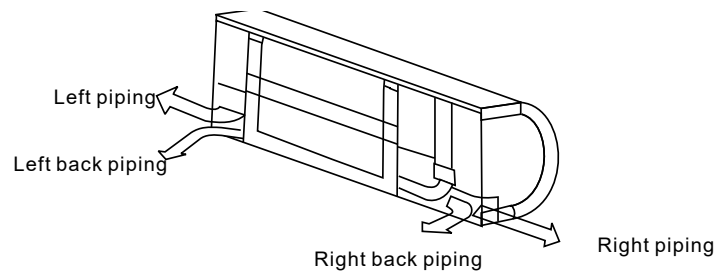

- ◆ Wind direction adjustment can be in horizontal and vertical way for auto swing louver

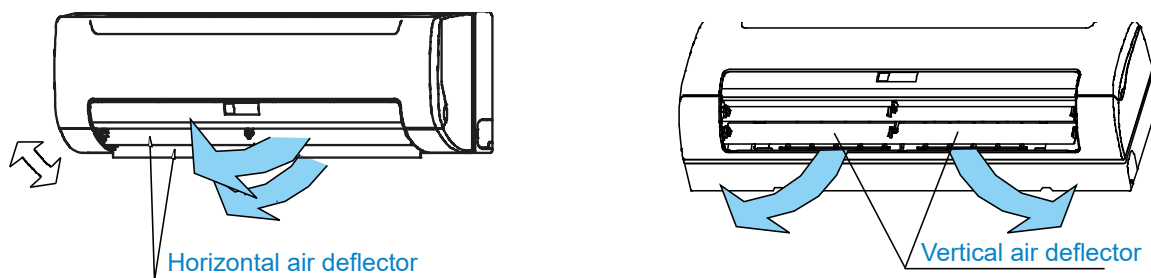

- ◆ Built-in 3-way electromagnetic valve.
- ◆ Cross flow fan creates quiet and comfortable environment.
- ◆ Easy maintenance has been realized as the front panel can be removed for easy access.

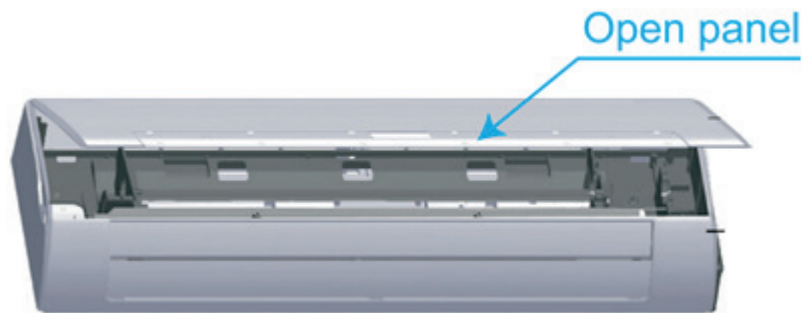

- ◆ Remote controller with LCD display is standard, wired controller and central controller are optional.
- ◆ Four-speed motor with super high speed reserved for more choice.
- ◆ Eurovent certified performance.

You can get the eurovent information of our products from: <http://www.eurovent-certification.com>



7. Dimensions

C-panel

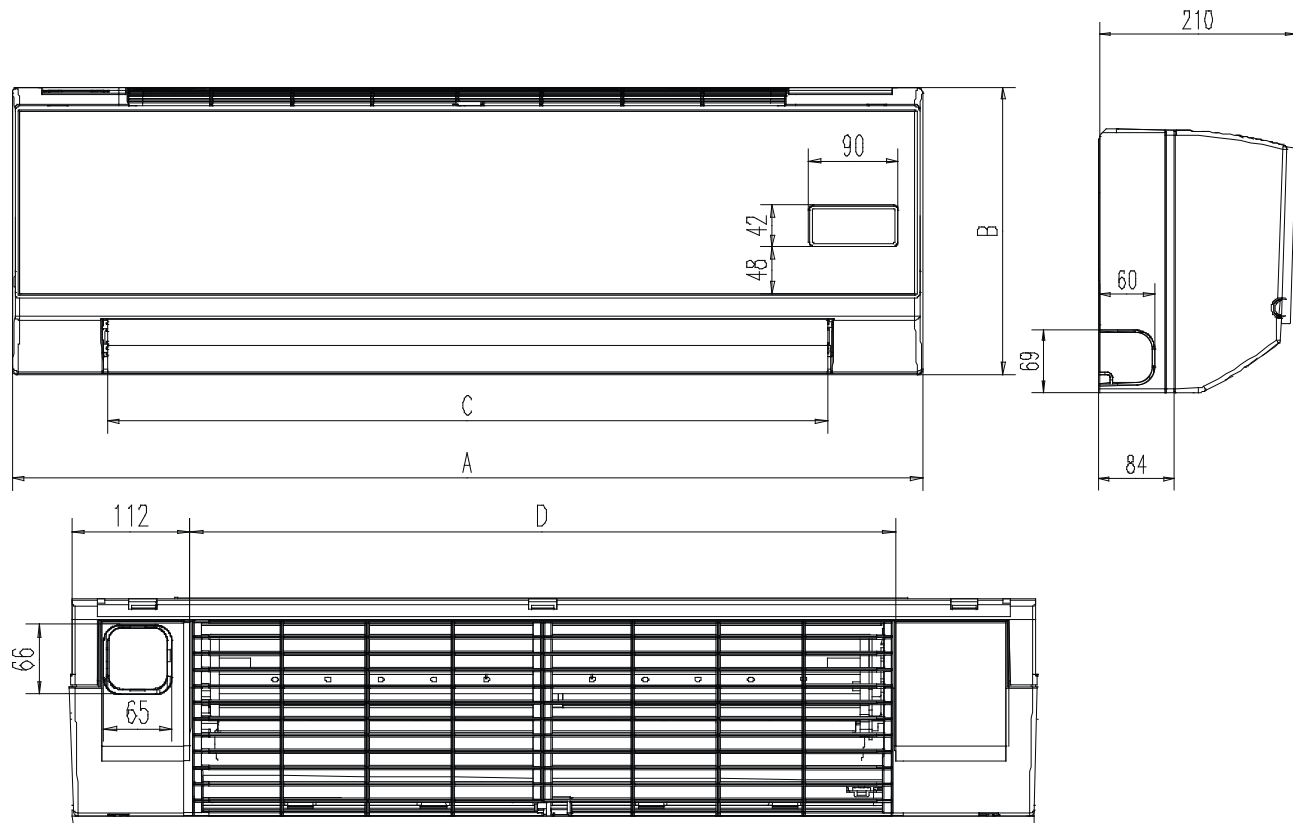

Model	MKG-250	MKG-300	MKG-400	MKG-500	MKG-600
A	915	915	915	1070	1070
B	290	290	290	315	315
C	725	725	725	885	885
D	670	670	670	815	815

S-panel

MKG-250-B, MKG-300-G, MKG-400-B

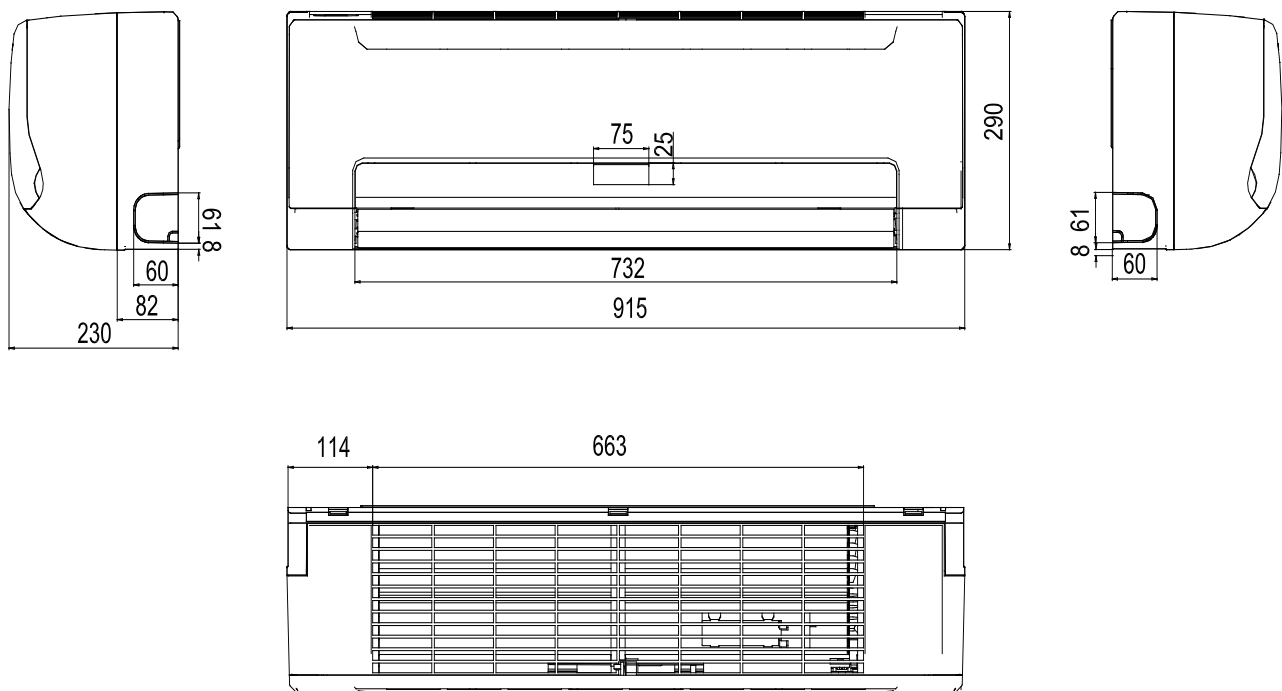

MKG-500-B, MKG-600-B

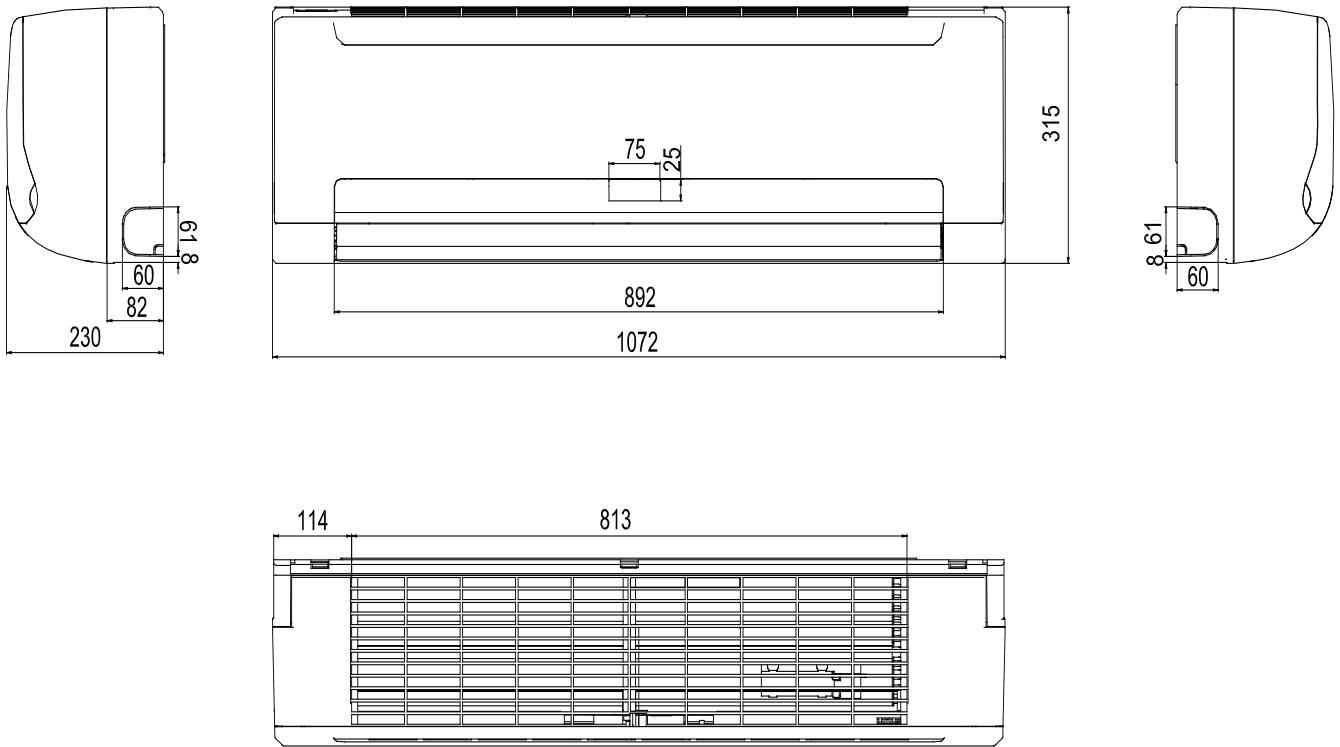

8. Service Spaces

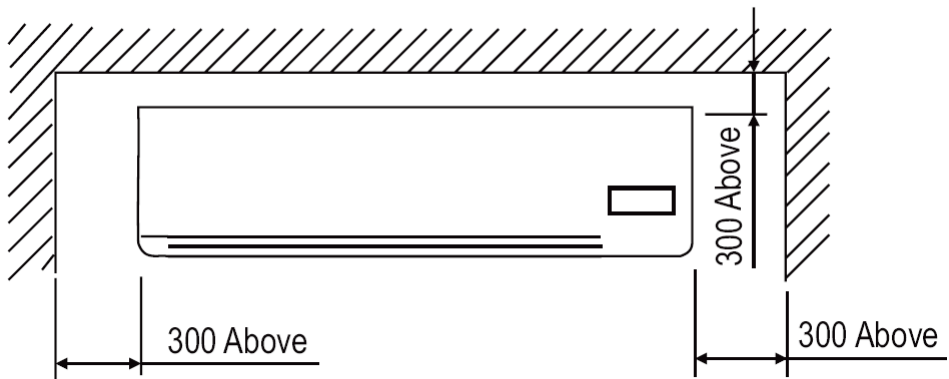

11. Sound Levels

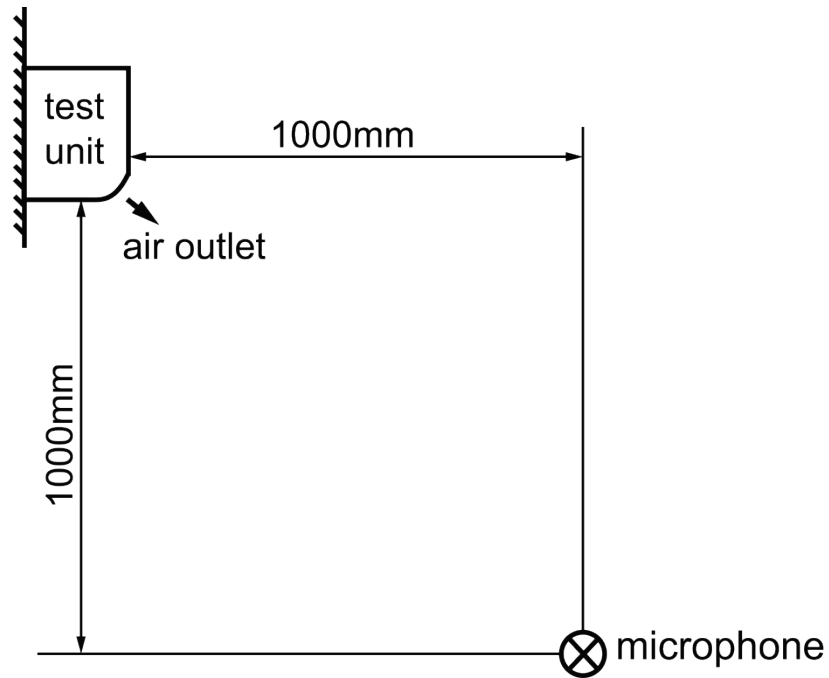

Series	Model	Noise level under three speeds of fan [dB(A)]		
		H	M	L
C panel	MKG-250	30	24	20
	MKG-300	35	29	24
	MKG-400	37	31	26
	MKG-500	39	33	28
	MKG-600	40	34	29
S panel	MKG-250-B	30	24	20
	MKG-300-B	35	29	24
	MKG-400-B	37	31	26
	MKG-500-B	39	33	28
	MKG-600-B	40	34	29

13. Installation

13.1 Installation Attention

※ **Warning:**

- **Be sure only trained and qualified service personnel to install, repair or service the equipment.**
Improper installation, repair, and maintenance may result in electric shocks, short-circuit, leaks, fire or other damage to the equipment.
- **Install according to this installation instructions strictly.**
- **If installation is defective, it will cause water leakage, electrical shock and fire.**
- **When installing the unit in a small room, take measures against to keep water concentration from exceeding allowable safety limits in the event of water leakage.**
Contact the place of purchase for more information.
- **Use the attached accessories parts and specified parts for installation.**
Otherwise, it will cause the set to fall, water leakage, electrical shock fire.
- **Install at a strong and firm location which is able to withstand the set's weight.**
If the strength is not enough or installation is not properly done, the set will drop to cause injury.
- **The appliance must be installed 2.3m above floor.**
- **The appliance shall not be installed in the laundry.**
- **Before obtaining access to terminals, all supply circuits must be disconnected.**
- **The appliance must be positioned so that the plug is accessible.**
- **The enclosure of the appliance shall be marked by word, or by symbols, with the direction of the fluid flow.**
- **For electrical work, follow the local national wiring standard, regulation and this installation instruction. An independent circuit and single outlet must be used.**
If electrical circuit capacity is not enough or defect in electrical work, it will cause electrical shock fire.
- **Use the specified cable and connect tightly and clamp the cable so that no external force will be acted on the terminal.**
If connection or fixing is not perfect, it will cause heat-up or fire at the connection.
- **Wiring routing must be properly arranged so that control board cover is fixed properly.**
- **If control board cover is not fixed perfectly, it will cause heat-up at connection point of terminal, fire or electrical shock.**
If the supply cord is damaged, it must be replaced by the manufacture or its service agent or a similarly qualified person in order to avoid a hazard.
- **An all-pole disconnection switch having a contact separation of at least 3mm in all poles should be connected in fixed wiring.**
- **Do not modify the length of the power supply cord or use of extension cord, and do not share the single outlet with other electrical appliances.**
Otherwise, it will cause fire or electrical shock.
- **Carry out the specified installation work after taking into account strong winds, typhoons or earthquakes.**
Improper installation work may result in the equipment falling and causing accidents.
- **If the water leaks during installation, ventilate the area immediately.**
- **After completing the installation work, check that water does not leak.**

※ **Caution:**

- **Ground the air conditioner.**
Do not connect the ground wire to gas or water pipes, lightning rod or a telephone ground wire. Incomplete grounding may result in electric shocks.
- **Be sure to install an earth leakage breaker.**
Failure to install an earth leakage breaker may result in electric shocks.

- **Connect the outdoor unit wires, then connect the indoor unit wires.**

You are not allowed to connect the air conditioner with the power source until wiring and piping the air conditioner is done.

- **While following the instructions in this installation manual, install drain piping in order to ensure proper drainage and insulate piping in order to prevent condensation.**

Improper drain piping may result in water leakage and property damage.

- **Install the indoor and outdoor units, power supply wiring and connecting wires at least 1 meter away from televisions or radios in order to prevent image interference or noise.**

Depending on the radio waves, a distance of 1 meter may not be sufficient enough to eliminate the noise.

- **The appliance is not intended for use by young children or infirm persons without supervision.**













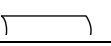

- **Don't install the air conditioner in the following locations:**

- There is petrolatum existing.
- There is salty air surrounding (near the coast).
- There is caustic gas (the sulfide, for example) existing in the air (near a hot spring).
- The Volt vibrates violently (in the factories).
- In buses or cabinets.
- In kitchen where it is full of oil gas.
- There is strong electromagnetic wave existing.
- There are inflammable materials or gas.
- There is acid or alkaline liquid evaporating.
- Other special conditions.

※ **Installation Order:**

- Select the location;
- Install the indoor unit;
- Install the outdoor unit;
- Connect the drain pipe;
- Wiring;
- Test operation.



13.2 Accessory

Name	Shape	Quantity	Function
Installation board		2	_____
Screw ST3.9x25 for installation board		3	Secure the installation board
Plastic expanded tube		3	_____
Wrapping tape		1	_____
Drain pipe		2	_____
Sealing clay		2	_____
Wall conduit cover		1	_____
Remote controller (including operation manual)		1	_____
Frame		1	Hold the remote controller
Mounting screw(ST2.9×10-C-H)		2	Insulation Holder for remote controller
Alkaline dry batteries (AM4)		2	_____
Owner's manual		1	_____
Installation manual		1	_____
12. seel gasket		4	For connecting water pipe

13.3 Inspecting and Handling the unit

At delivery, the package should be checked and any damage should be reported immediately to the carrier claims agent.

When handling the unit, take into account the following:

-  Fragile, handle the unit with care.
-  Keep the unit upright in order to avoid compressor damage.
- Choose on beforehand the path along which the unit is to be brought in.
- Move this unit as originally package as possible.
- When lifting the unit, always use protectors to prevent belt damage and pay attention to the position of the unit's centre of gravity.

13.4 Indoor Unit Installation

13.4.1 Installation place

Installation in the following places may cause trouble. If it is unavoidable, please consult with the local dealer.

- A place full of machine oil.
- A saline place such as coast.
- A place full of sulfide gas such as hot-spring resort.
- Places where there are high frequency machines such as wireless equipment, welding
- Machine and medical facility.
- A place there is no combustive gases and volatile matter.
- A place of special environmental conditions.

Installation in the following places:

- ✓ A place where is no obstacle near the inlet and outlet area.
- ✓ A place which can bear the indoor unit.
- ✓ A place which is convenient to maintenance.

- ✓ A place which provides the space around the indoor unit as required right in the diagram.
- ✓ There is strong electromagnetic wave existing.
- ✓ A place which is far from heat, steam and inflammable gas.

13.4.2 Drilling A Hole and Mounting Installation Board

Installation Board and Its Direction (unit: mm)

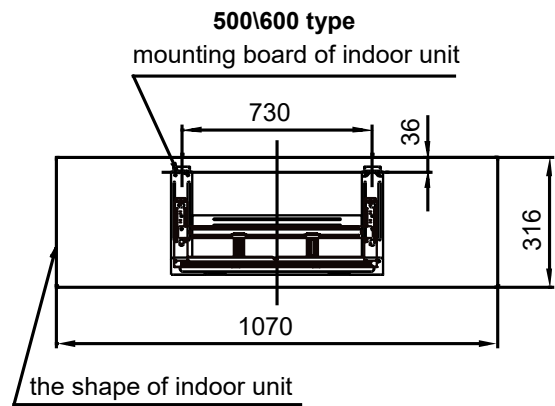
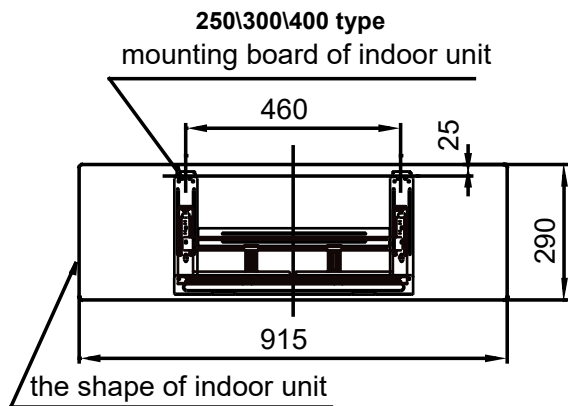

■ Fix the installation board

- Install the installation board horizontally on structural parts on the wall with the spaces provided around the plate.
- In case of brick, concrete or similar type walls, make 5mm dia. holes on the wall. Insert clip anchors for appropriate mounting screws.
- Fix the installation board on the wall.

Right installation

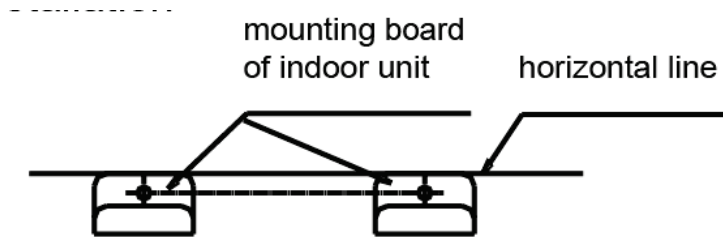

False installation

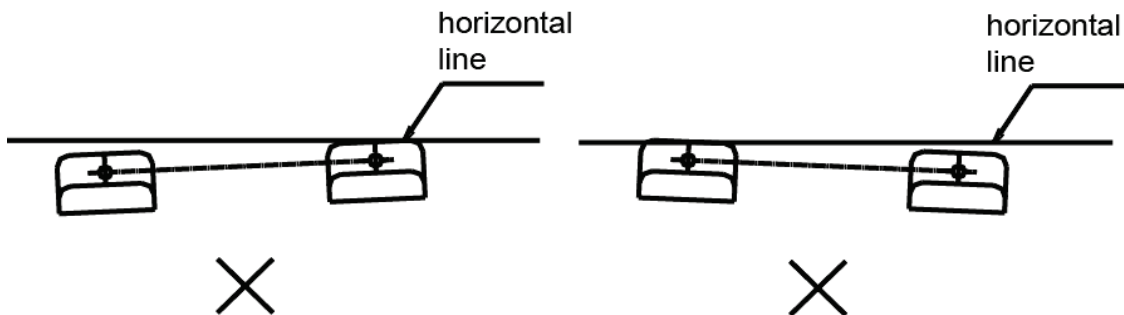

■ Drilling a hole

- Determine the pipe hole position using the installation board, and drill the pipe hole (N95mm) so it slants slightly downward.
- Always use a wall hole conduit when piercing metal lath, ply wood or metal plate.

13.4.3 Connective Pipe and Drainage Installation

■ Drainage

Run the drain hose sloping downward. Do not install the drain hose as illustrated below.

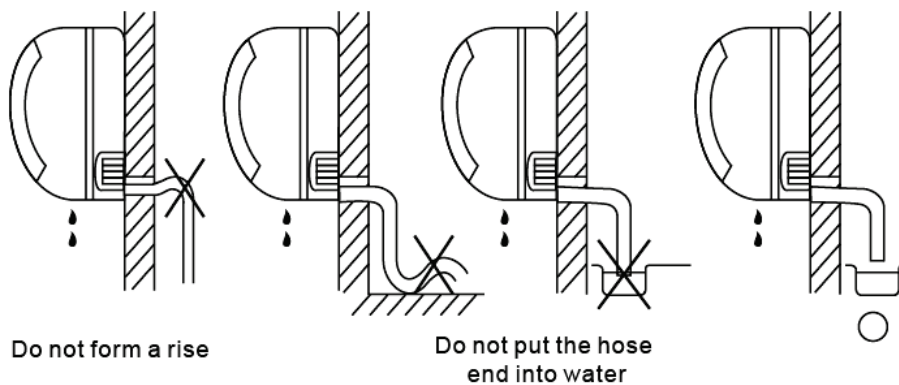

When connection extension drain hose, insulate the connecting part of extension drain hose with a shield pipe.

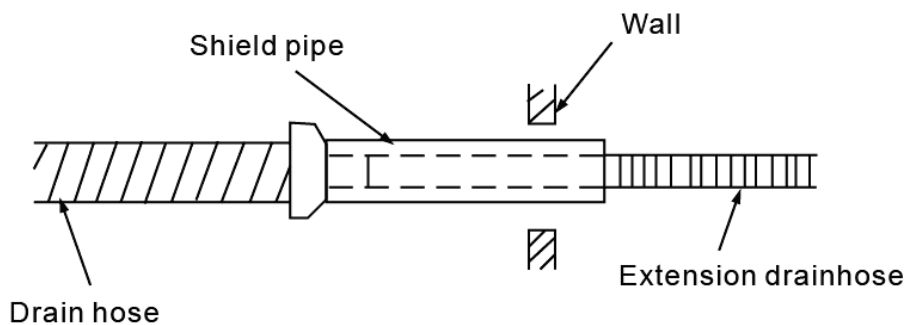

■ Connection pipe

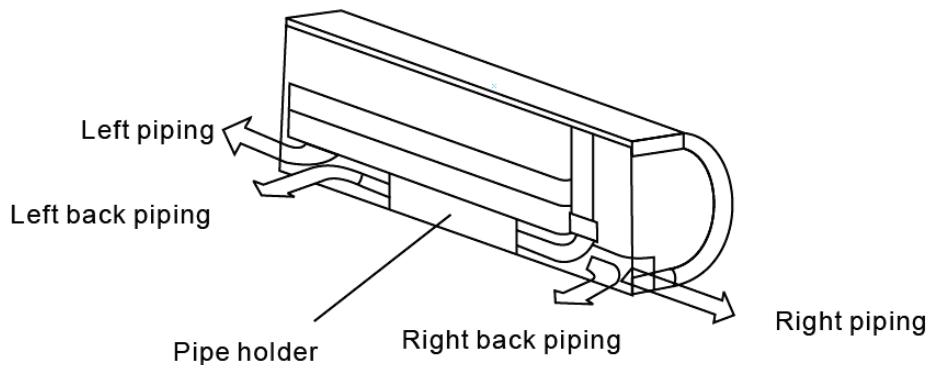

1. When install the water pipe of G unit, please following it

a) Put down two screws between the pipe holder and unit, and then get down pipe holder. (Refer to the following fig)

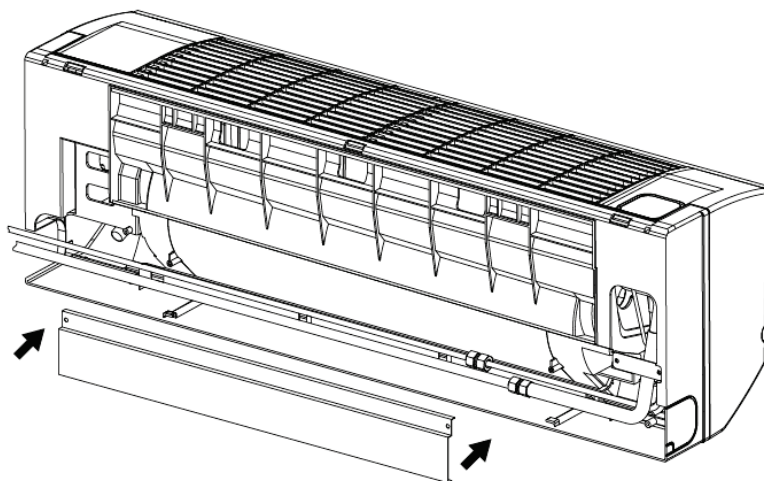

- b) Connect pipe.
- c) Install the pipe holder. (Refer to the following fig)

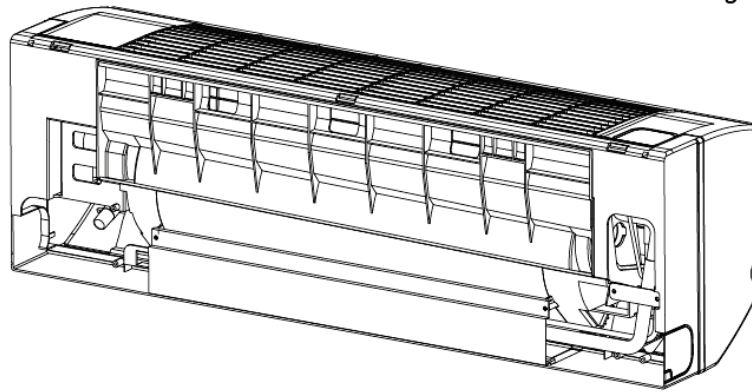

2. For the left-hand and rear-left-hand piping, install the piping as shown. Bend the connective pipe to be laid at 43mm height or less from the wall.

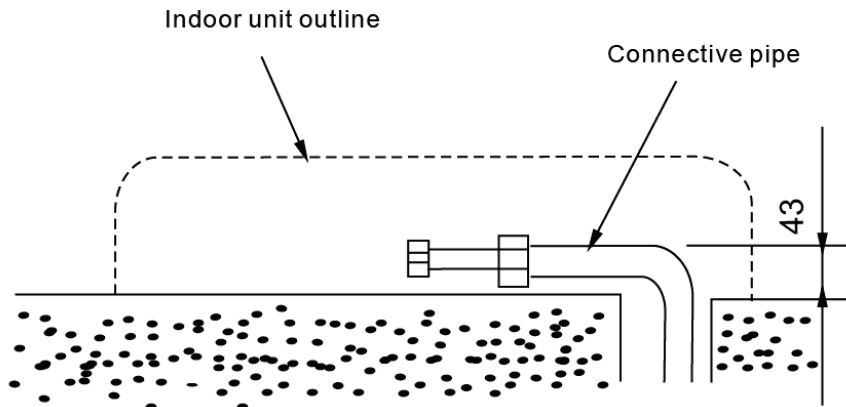

3. Fix the end of the connective pipe.

Caution:

- Connect the indoor unit first then the outdoor unit and bend and arrange the pipe carefully.
- Do not allow the piping to let out from the back of the indoor unit.
- Be careful not to let the drain hose slack.
- Insulate both of the auxiliary piping.
- Banding the drain hose under the auxiliary pipe.
- Do not allow the piping to let out from the back of the indoor unit.

■ Piping and bandaging

Wind the connective cable, drain hose and wiring with tape securely, evenly as shown below.

Because the condensed water from rear of the indoor unit is gathered in Pond Box and is piped out of room. Do not put anything else in the box.

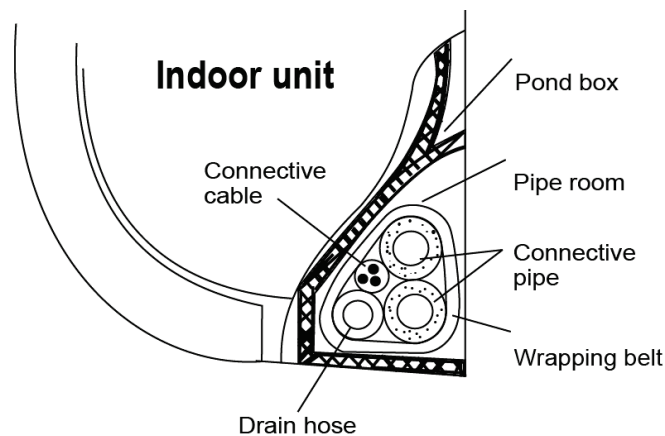

13.4.4 Indoor Unit Installation

- Pass the piping through the hole in the wall.
- Put the claw at the back of the indoor unit on the hook of the installation board, move the Indoor Unit from side to

side to see that it is securely hooked.

- Piping can easily be made by lifting the indoor unit with a cushioning material between the indoor unit and the wall. Get it out after finish piping.
- Push the lower part of the Indoor Unit up to the wall, then move the Indoor Unit from side to side, up and down to check if it is hooked securely.

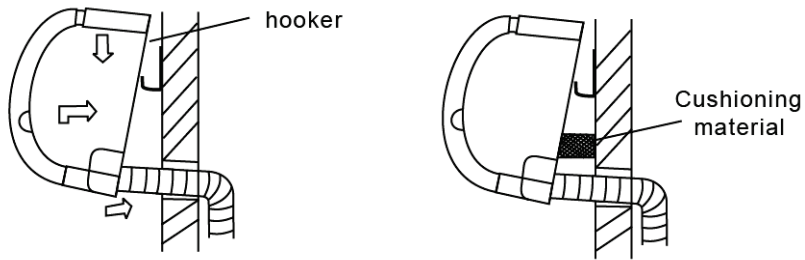

13.5 Water Pipe Installation

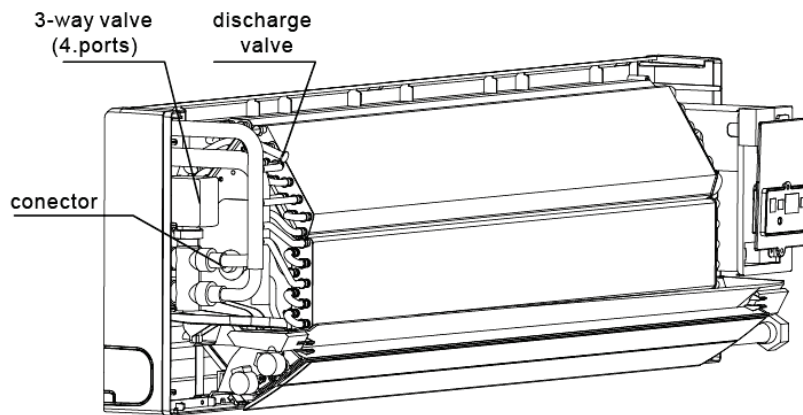

Material and Size of the Piping

Pipe material	Copper Pipe for Air Conditioner	
Model	250/300/400	500/600
Coil connections (flat plate)	3/4"	3/4"
	3/4"	3/4"

Connection of the water pipe should be done by professionals. Double-span should be used when connecting pipes of Indoor Unit.

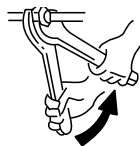

At the first debugging, completely expel air from coils via expelling valve.

